

Your Local Window Company

With The Big Reputation

Tel 01865 788333

Fax 01865 788334

www.admiralwindows.co.uk



CARE GUIDE

HELPING YOU GET THE BEST OUT OF YOUR HOME IMPROVEMENT PRODUCTS.

This booklet offers advice for the maintenance of your installation, failure to maintain your installation could make your guarantee void.



Introduction

This leaflet shows you how to operate, clean and maintain your home improvements to help prolong their life.

Please read through this document in conjunction with your suppliers Terms and Conditions and Guarantee Document. Failure to carry out regular cleaning and maintenance in accordance with these instructions may invalidate the Guarantee.

During their lifetime your products may require minor adjustments to compensate for normal wear and tear. Please refer to sections on adjustment and trouble shooting.

If you think you have a problem with your windows or doors, before calling for assistance, please read through this trouble shooting guide. There may be a quick and easy fix to your problem.

Contents

Operating	3
Cleaning	13
Lubrication and Maintenance	18
Adjustments	22
Trouble Shooting	24
• I have a draught around my window/door	
• Water is visible in my frame	
• Casement windows	25
• Tilt Turn windows	27
• Doors	28
• Conservatories	28
• Condensation	29
• Visual quality of sealed units	31
Gutters, Downpipes, Box gutters, Roofline & Fascias	32
Most commonly asked questions	34

PLEASE NOTE THAT CERTAIN MANUFACTURERS OF YOUR HOME IMPROVEMENT PRODUCTS MAY USE DIFFERENT OPENING AND CLOSING MECHANISMS TO THOSE ILLUSTRATED WITHIN THIS PUBLICATION.

Casement window operation

Some handles will lock when depressing button.

To open sash unlock with key and remove. Depress the thumb button and rotate handle 90 degrees. When closed turning the key will deadlock the handle. Remove the key for security and child safety .

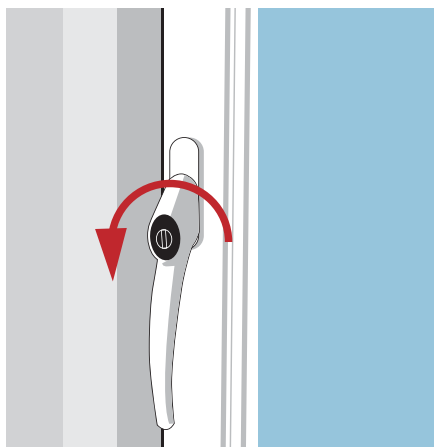

Fig 1.

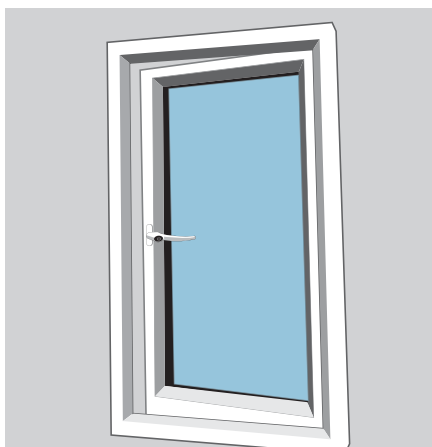

Fig 2.

When closing top hung windows try not to pull downwards on the window handle, as you pull the window into the closed position.

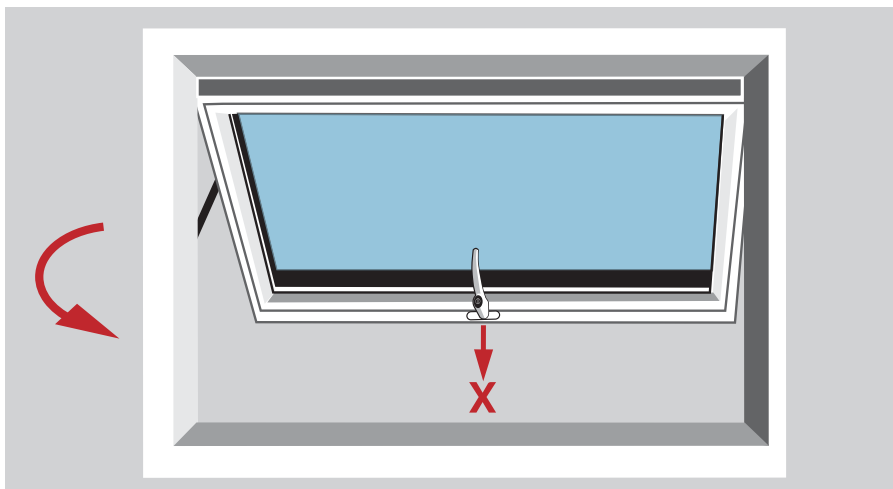

Fig 3.

Operating casement 'flying mullion' windows

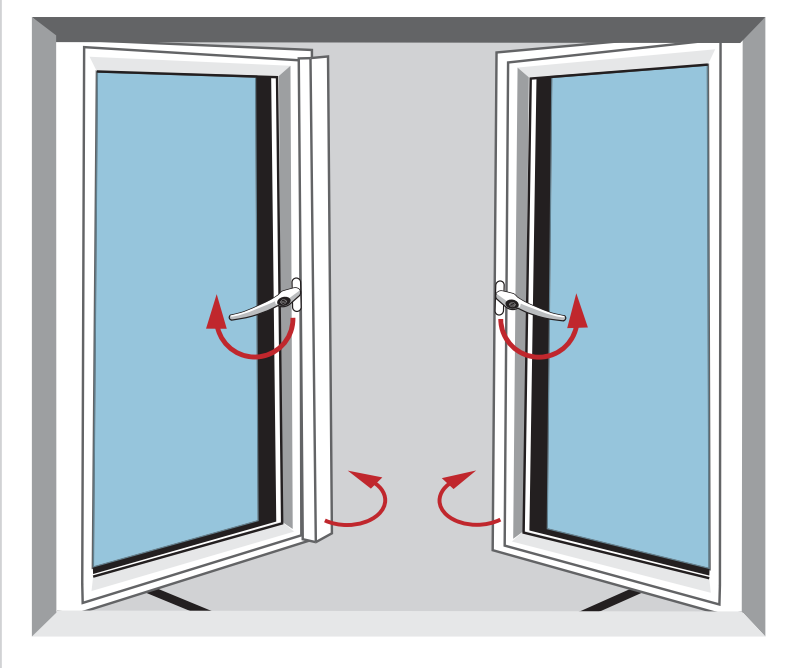

Fig 4.

Opening your window

To open your flying mullion window unlock the handle on your primary sash with the keys provided.

This will only be required if your window has been supplied with a locking handle.

Push the button on the handle and turn in the opening direction. This window can now be pushed open.

Repeat this process on the secondary sash to fully open your flying mullion window.

Closing your window

To close the window move the secondary sash back to its closed position and return the handle to its original position.

This will throw the shootbolts into the locked position.

Repeat this operation on the primary sash to fully close your window

Tilt and turn window operation

Unlock by rotating key one quarter turn. Turn the handle 90 degrees and gently pull the sash towards you. This will allow the sash to tilt inwards at the top for controlled ventilation.

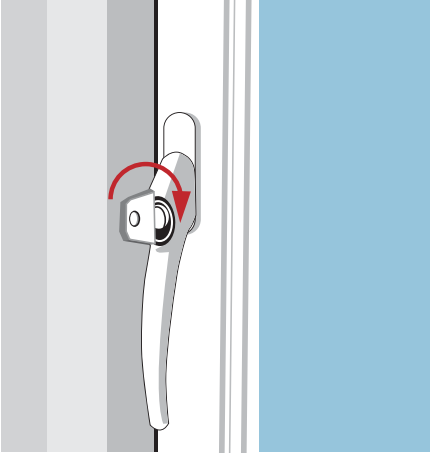

Fig 5.

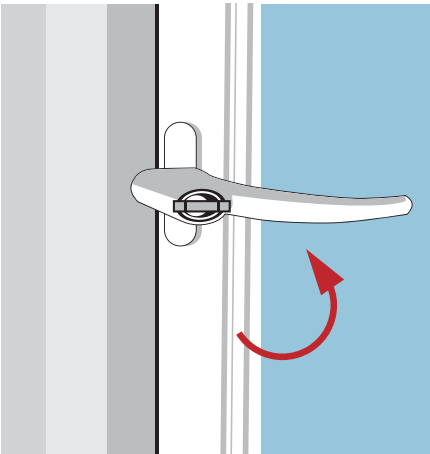

Fig 6.

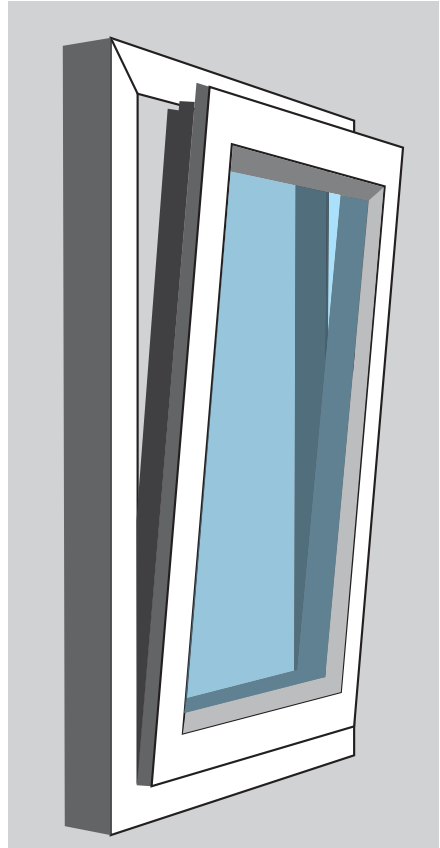

Fig 7.

Tilt and turn window operation

To open the window to turn mode, push the sash closed then rotate the handle a further 90 degrees to the vertical and gently pull the window. This will allow the sash to turn inwards towards you.

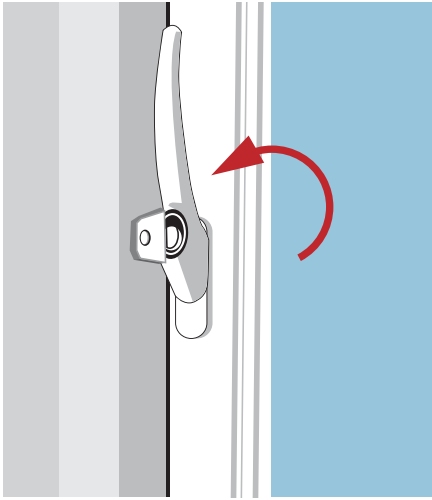

Fig 8.

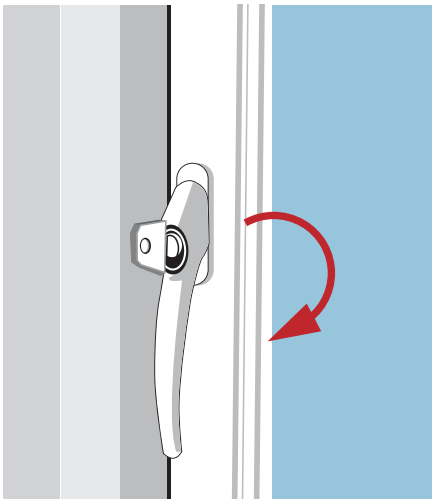

Fig 9.

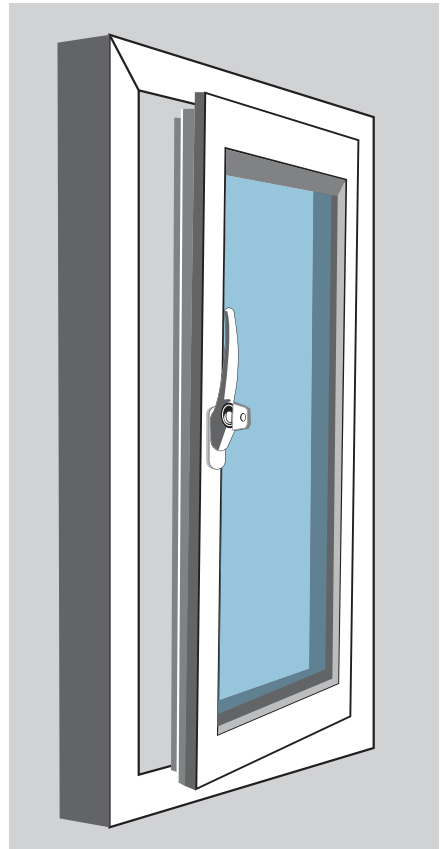

Fig 10.

To shut the window push the sash closed and then rotate the handle downwards.

Vertical sliding windows

Unlock catch with key and rotate lever through a half turn.

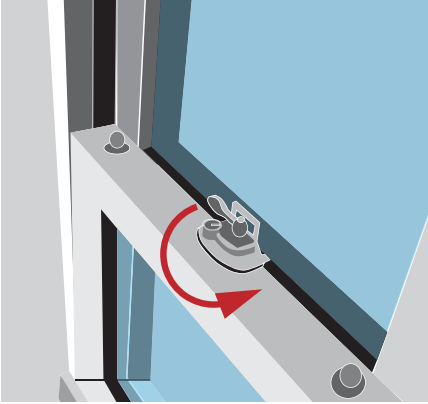

Fig 11. Locked.

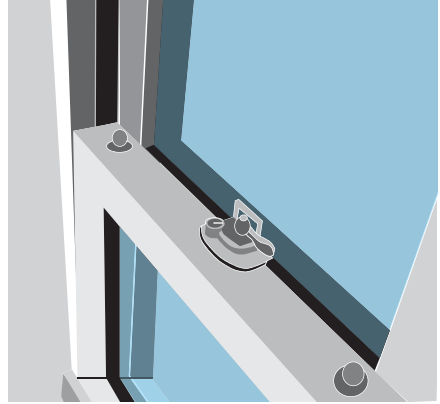

Fig 12. Unlocked.

Sashes can then be slid open for ventilation.

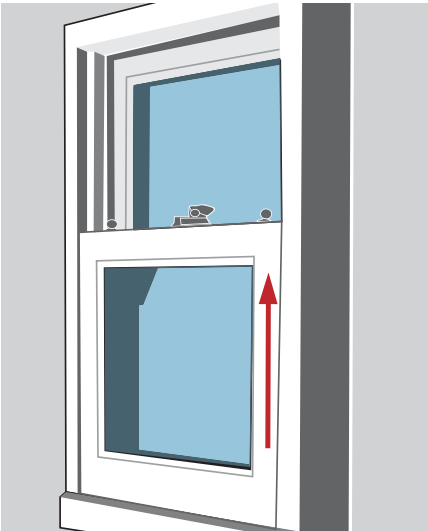

Fig 13.

To clean the outside panes, slide sash open approx 100mm and retract the jamb catches by sliding the tilt knobs inwards on the top of each sash. The sash weight will be supported on a turn arm.

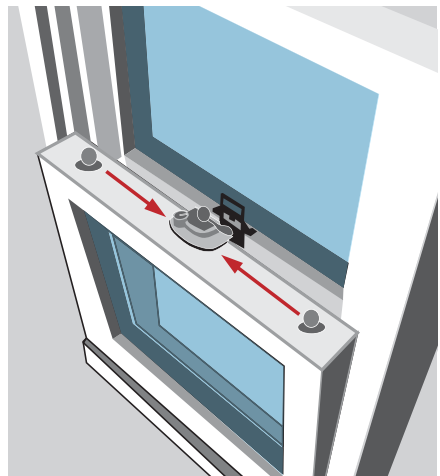

Fig 14.

Vertical sliding windows

Some windows are fitted with spring loaded child restrictors, which limit the opening of either sash to approx 100mm. They can be locked in the open or closed position.

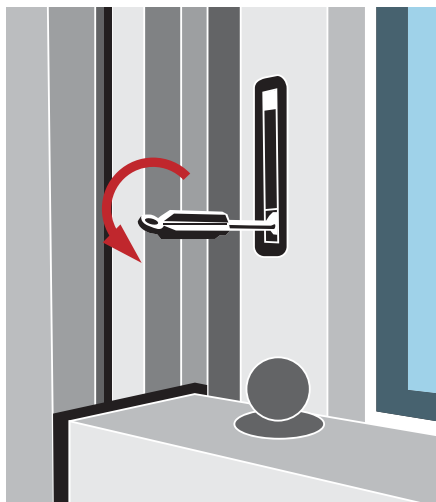

Fig 15. Closed – rotate 'key' to undo



Fig 16. Open position – rotate key to lock

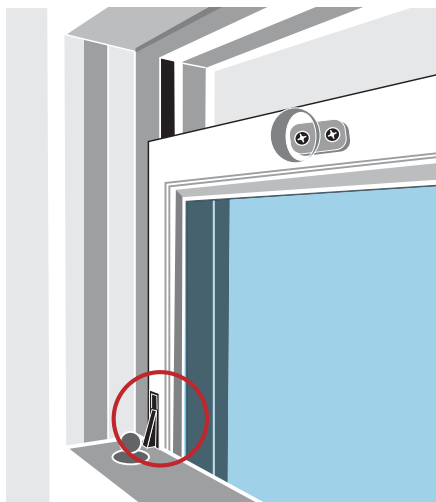

Fig 17. Limited sash opening

Single door operation

Locking from inside or outside

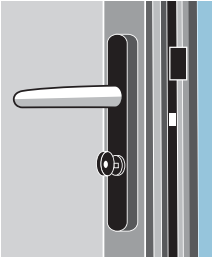

Fig 18. Step 1 - Unlocked.

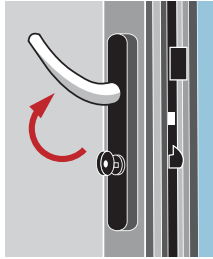

Fig 19. Step 2 – Lift handle upwards as far as it will go. This engages all hook bolts.

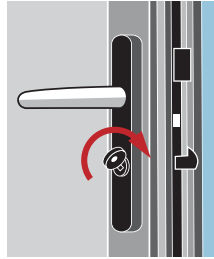

Fig 20. Step 3- Turn key one full turn towards lock edge to deadlock all hook bolts and the latch bolt.

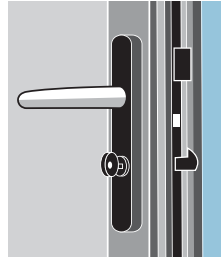

Fig 21. Step 4 – Locked.

Unlocking form inside or outside

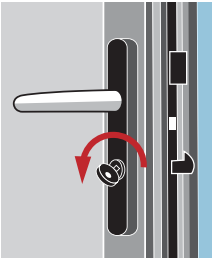

Fig 22. Step 1 – turn the key one full turn away from the lock edge to disengage the deadlock.

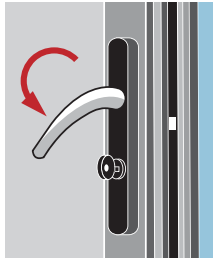

Fig 23. Step 2 – push the handle down to retract the hook bolts and the latch. This allows the door to be opened.



Fig 24. Step 3 – Some front door applications require a turn of the key to retract the latch bolt from outside. Turn the key away from the lock edge to retract the latch bolt.

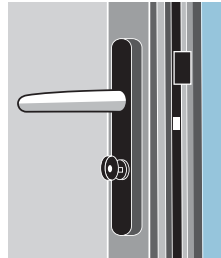

Fig 25. Step 4 – unlocked

Snib operation

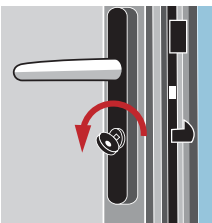

Fig 26.

To keep latch in the retracted position so that temporary access from the outside is possible without the key. Push down the handle on the inside to retract the latch and slide the white button which is located on the face plate, upwards

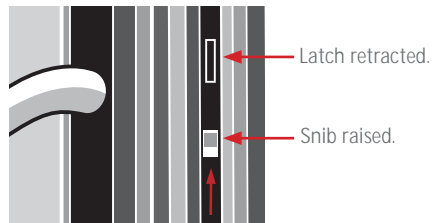

Fig 27.

Double door operation (French doors)

French doors open and shut in a similar way to a single door. The difference comes in the built in security feature, whereby the primary door cannot be locked without the shootbolts engaged on the secondary door.

Unlocking form inside or outside

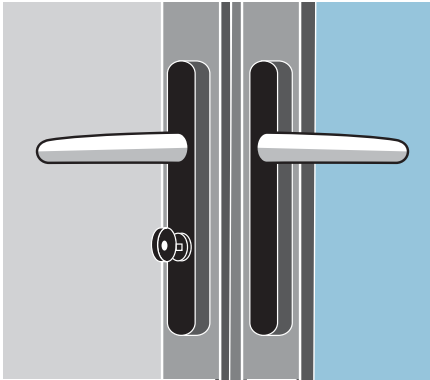

Fig 28. Locked.

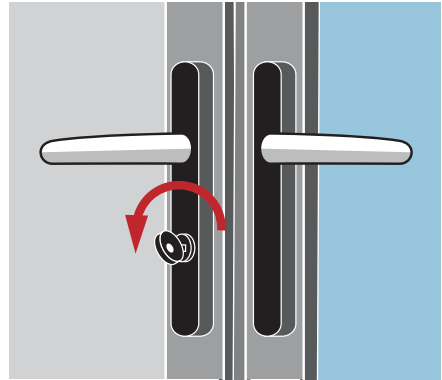

Fig 29. Turn the key one full turn away from the lock edge to disengage the deadlocking of the latch bolts and hook bolts.



Fig 30. Push the handle down to retract the latch bolt and hook bolts. This allows the primary door to be opened.

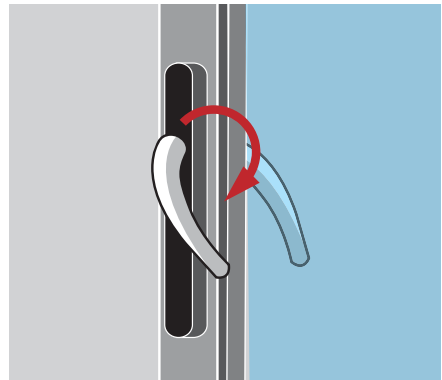

Fig 31. Then, to open the secondary door simply push the handle down to retract the top and bottom shootbolts.

Double door operation (French doors)

Locking from inside or outside

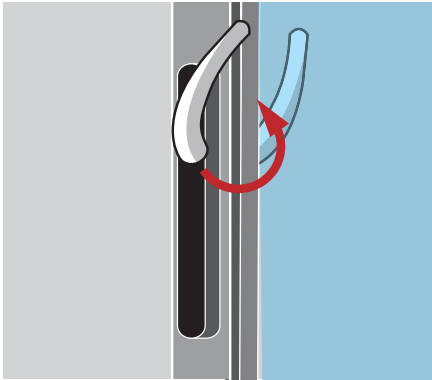

Fig 32. Close the secondary door. Lift the handle upwards as far as it will go. This engages all top and bottom shootbolts.

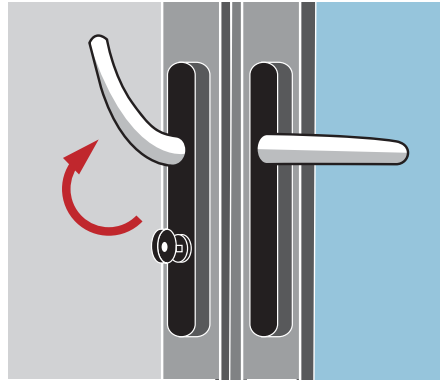

Fig 33. Close the primary door. Lift the handle upwards as far as it will go.

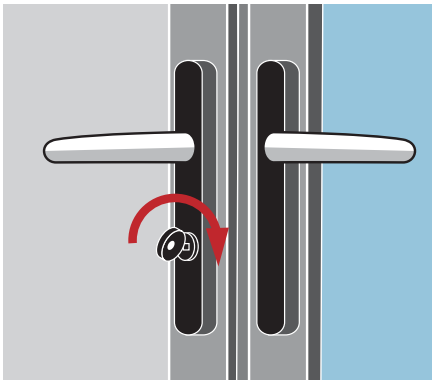

Fig 34. To finally lock the pair of doors, turn the key one full turn towards the lock edge to deadlock all hook bolts and the latch bolt



If the secondary handle has not been lifted, then the primary door hooks will not engage.

Sliding patio doors operation

Sliding doors have two locking mechanisms. A four point lock at the jamb and either one or two plunger locks to the central meeting stiles to lock the panes together



Begin by unlocking the plunger locks

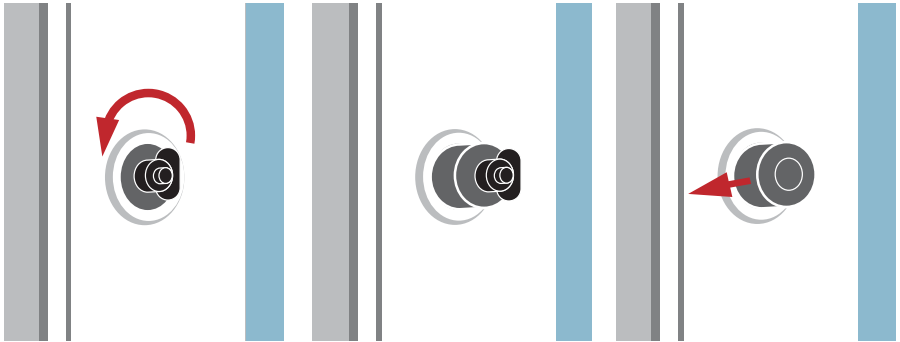

Fig 35. To unlock the centre plunger lock rotate key until plunger retracts. To lock, once the sliding door is closed, simply push the plunger closed.

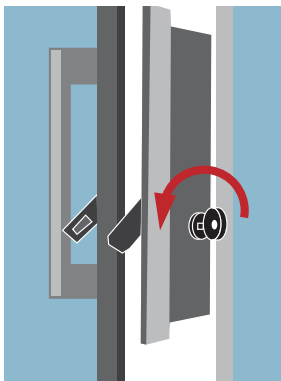

Fig 36.

Jamb lock

Turn key one full turn away from the lock edge to unlock.

Lift the lever fully to disengage the lock bolts from the jamb.

Locking is simply the reverse action

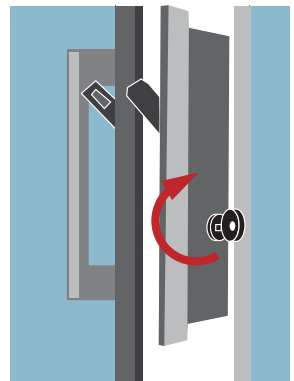

Fig 37.

Cleaning

Guidelines for cleaning your home improvement products

Regular careful cleaning of your products is required to prevent the build up of everyday grime and atmospheric pollutants and help prolong their life.

Before cleaning your products please read the list of do's and don'ts to make sure you are not using inappropriate cleaning materials.

Please do clean your product with plenty of clean, warm soapy water (washing up liquid is suitable) and wipe dry with a clean, soft cloth. The need for cleaning will vary by position and the environmental conditions in your area but in general we would recommend that your windows and doors should be cleaned at least once every two months.

Please do be particularly careful when cleaning products with decorative finishes such as Rich Mahogany, Rosewood, Golden Oak, White Foil and Dual Product PVC-U to avoid damage to the decorative service.

Please do always ensure that the drainage slots are kept unblocked and free from dirt, grit, spider's webs, etc. This will allow any water that appears in the frame to drain away and prevent any leaks (fig 38)

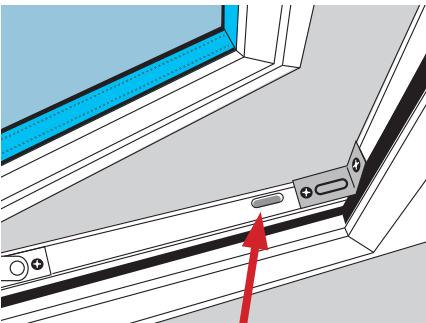

Fig 38.

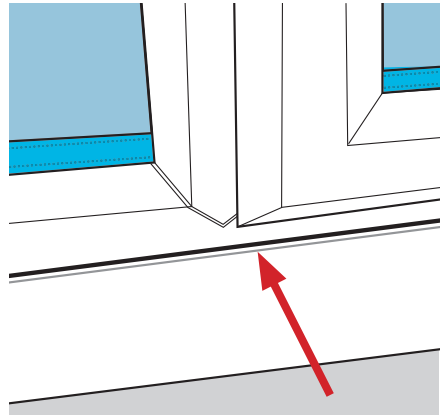

Fig 39.

Please do keep the small gap between your sill and window on the outside clear of any dirt to allow for drainage (fig 39)

Please do keep casement window hinges, vertical slider and sliding door tracks clear of dust and debris to reduce wear on sliding parts.

Please do not use abrasive cleaners or scouring pads.

Please do not use any type of harsh cleaning agents such as bleach, solvents, aerosol products such as WD40, automotive dashboard wipes, acids, brick wash solutions or alkalis.

Please do not use excessive pressure when cleaning PVC-U.

Please do not use high pressure or steam cleaners.

Cleaning your Glass

Clean glass using clean, warm soapy water or glass cleaner. If you are using glass cleaner apply it to cloth to avoid getting excess glass cleaner on PVC-U. Both warm soapy water and glass cleaner can be used on lead effects.



Cleaning

Your Composite Door

Your composite door has been coated with a high quality paint finish. To keep your door looking good and to minimise environmental effects regular cleaning is essential. This will prevent the build up of every day grime and prolong the life of the painted surfaces.

The need for cleaning will vary by door position and environmental conditions in your area but in general we would recommend that your door should be cleaned at least once every two months.

Please do frequently wash down the painted surface with plenty of clean soapy water and wipe dry with a clean, soft cloth.

Please do clean seal around the door frame so that trapped dirt does not damage the painted surface.

Please do clean the glass regularly with your installer approved glass cleaner or any clear liquid spray type glass cleaner. Spray directly onto cloth to avoid getting excess cleaner onto the painted surface.

Please do occasionally remove discolouration, caused by oxidation, to restore the appearance of your door by gently polishing with 3M Hand Glaze after washing.

Please do use your installers approved cleaning products.

Please do apply your installers approved touch-up paint to minor scratches and chips.

Please do not use abrasive cleaners or scouring pads on the painted surface or door furniture.

Please do not use high pressure or steam cleaners

Please do not use any type of harsh cleaning agents such as bleach, solvents, aerosol products such as WD40, automotive dashboard wipes, acids, brick wash solutions, or alkalis

Please do not use Paints other than those recommended by your installer.



Cleaning

Your Conservatories and Roof trim

Conservatory Roof Cleaning

Clean glass sealed units in the roof in a similar way to glass sealed units in your windows and doors. Clean polycarbonate roofing panels in a similar manner to PVC-V frames.



Take extreme care when accessing a conservatory roof. Never walk on the glass or polycarbonate part of the roof.

Please do not lean ladders against gutters or glass. Always use a stand-off device and use a ladder in accordance with the manufacturers instructions

If access is required on the roof, always create a safe platform by spreading weight across several rafters with timber boards – see fig 40. Ensure the timber boards are firmly secured in place to prevent slippage.

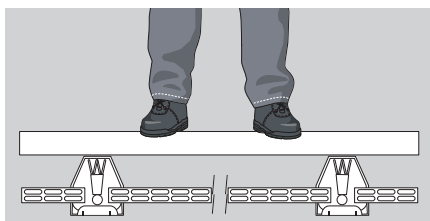

Fig 40. Timber boards used to spread weight across several rafters

Gutter and Boxgutters

Clear gutters of leaves and debris as required, to avoid overflow of rainwater and ensure unobstructed drainage.

Rooftrim

Cleaning of rooftrim, fascias, bargeboards, cladding and guttering is similar to window products. Wash regularly with clean, warm soapy water.

Guttering should be kept clear of dirt and leaf litter to allow water to flow.

Please do not

rest ladders on the product as this may cause damage. A ladder stand-off device should be used during cleaning – see fig 41.



Fig 41. Ladder stand-off device in use

All our products are designed for simple cleaning



Caution. Take care to avoid any risk of falling from an open window.

Casement Windows

Standard hinges open to allow access to clean the outside of your windows (as shown in fig 42)

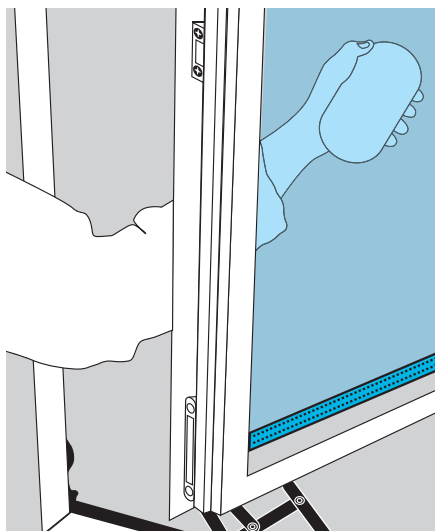

Fig 42.

For windows that require easy access in case of fire, the hinges open in a way to give the maximum opening but prevent the ability to clean the window from this position. These windows can be easily moved along the hinge track to allow for cleaning outside. (see fig 43)

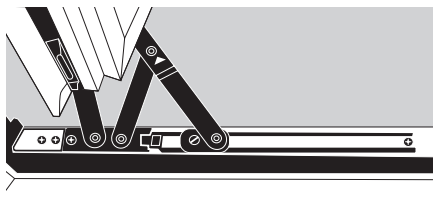

Fig 43. Open the sash until it is fully open.

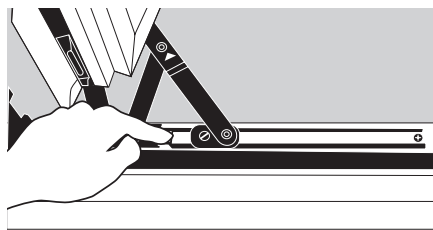

Fig 44 – Press down button on the bottom hinge and move the window slightly to the handle side to disengage the hinge. Repeat process for top hinge.



Take care not to trap fingers in the mechanism

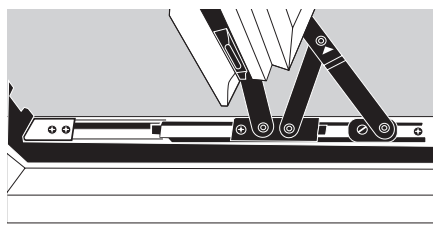

Fig 45 – Now the window is free to slide along the track to allow for easy access to clean your windows.

To close the window just pull the window handle inwards and the hinge will automatically return to its original position.

Secondary Double Glazing



Glazed sashes can be heavy.

Lift Out and Horizontal Sliders.

These can be lifted out for easy access to clean both the secondary double glazing and the window behind it.

Use the handle at the bottom of the lift out sash to slightly raise the pane, then tilt inwards at the bottom to remove. For the sliding sashes, slide the pane across so you can grip the sash on both sides. Lift the sash and tilt inwards at the bottom to remove.

Vertical Sliders

This type of window can be tilted inwards to enable the outside surface to be cleaned.

1. Raise the bottom sash by at least 75mm off the sill
2. Slide catches towards centre of the window (fig 46) while gently pulling sash inwards and rest it on a chair or a similar stable item (fig 47)
3. Slide top sash down to 75mm above the bottom sash and repeat the previous instructions this time resting it on the bottom sash (fig 48)
4. Clean the outer faces of glass of the top sash and return to its original position by tilting sash to the upright position and push firmly until spring catches engage into the outer frame.
5. Now clean the bottom sash and return it to its original position the same way as the upper sash .

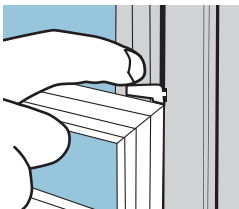

Fig 46.
Release catch

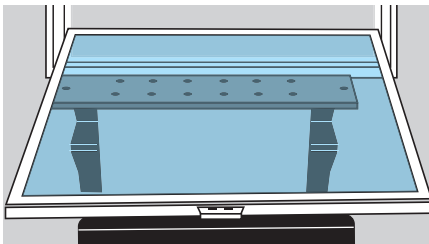

Fig 47. Tilt and rest inner sash

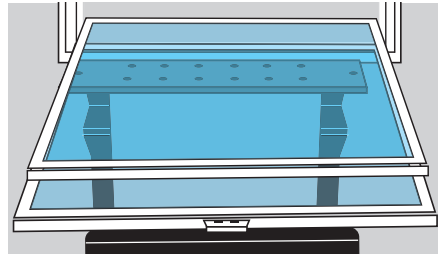

Fig 48. Tilt and rest inner sash

Vertical Sliding Sash Windows

This type can be tilted inwards to enable outside surfaces to be cleaned (fig 49)

1. Raise the bottom sash by at least 75mm off the sill.
2. Hold the top rail of the bottom sash.
3. Slide catches towards centre of window while gently pushing sash inwards until it stops (at 25 to 45 degrees) resting on the side arms. NB the sash cannot be moved up or down the frame when in tilted position.
4. Slide top sash down to 75mm above the bottom sash and repeat the previous instructions.
5. Lower the sash very carefully until it rests securely on the side arms.
6. Clean the outer faces of the glass and PVC-U.
7. After cleaning, tilt sashes singly to the upright position and push firmly until spring catches engage into the outer frame.



Fig 49.

Lubrication and Maintenance

General

Regular lubrication of the moving components is necessary to keep your windows and doors operating properly. The following lubrication and maintenance checks should be carried out once a year.

Please do use a general light engineering oil with corrosion inhibitors such as 3-in-one Multi Purpose Oil (available in aerosol can for convenience).

Please do not use solvent based aerosol sprays such as WD40. These contain chemicals that attack components of your window. This can result in weakening and breaking of parts of the window and may stop them functioning. It will also damage decorative finishes.

Casement Windows

Hinges

Annually lubricate all pivot points with oil and wipe away excess (fig 50 and 51)

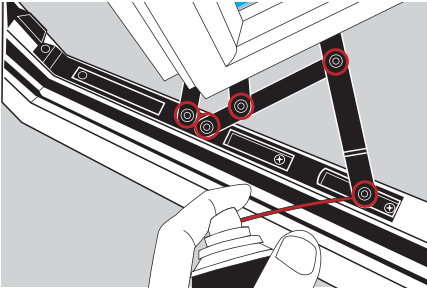

Fig 50. Hinge.

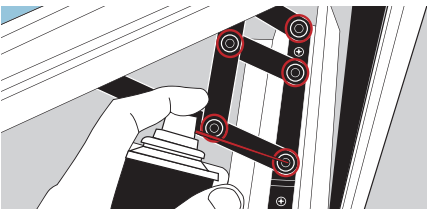

Fig 51. Hinge.

Locks

Annually lubricate the horseshoe slider (fig 52) and gearbox (fig 53) to help with ease of operation..

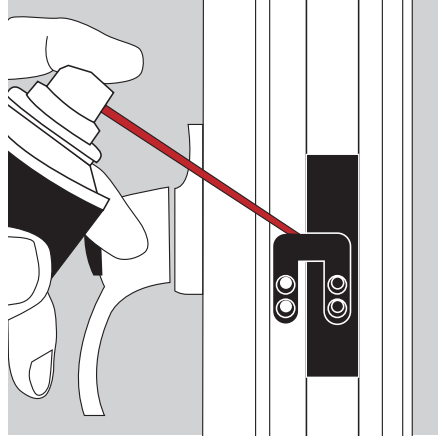

Fig 52. Horseshoe.

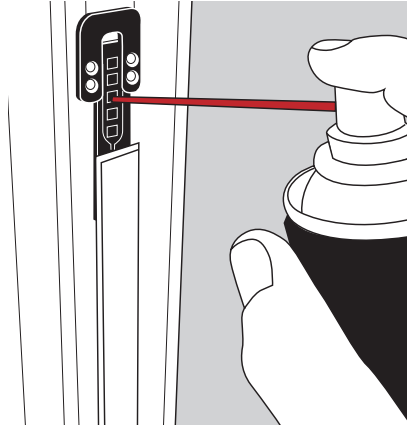

Fig 53. Gearbox.

Tilt Turn Windows

The diagram below (fig 54) indicates the exact points that require lubrication. A light spray or drop of oil applied annually to each point will be sufficient to keep your Tilt Turn windows in perfect working order.

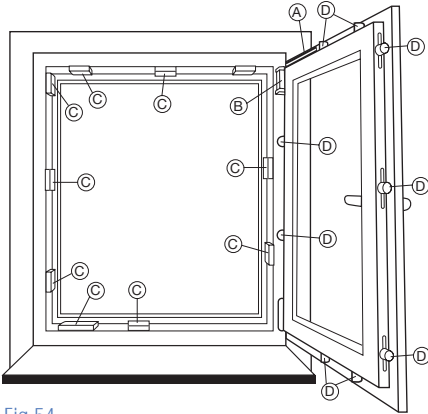

Fig 54.

- A. Top Arm (The Shear)
- B. Top Hinge (Shear Hinge)
- C. Keep
- D. Roller

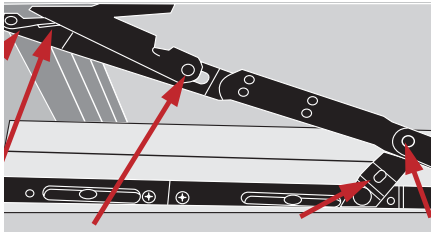

Fig 55. The Shear

A. Top Arm (The Shear)

The top arm must be oiled once a year, at all pivot points. Spray a small amount of oil to the points shown above. (fig 55)

The top hinge (fig 56) must be oiled once a year, at all pivot points. Spray a small amount of oil to the points shown. Remove the plastic cover if fitted, and spray a small amount of oil onto the top of the hinge (fig 57)

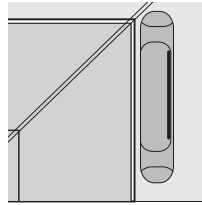

Fig 56. Top hinge.

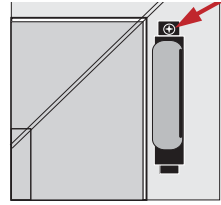

Fig 57. Lubricated top hinge.

B. Top Hinge

These are only fitted to Tilt Turn windows that open to 180 degrees and are generally fitted in conservatories. (fig 58)

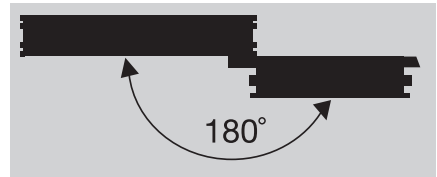

Fig 58.

C. Keeps

In order to maintain the smooth running action, the keeps must be lubricated once a year by applying industrial Vaseline or other suitable grease on the contact areas/leading edges (as highlighted in fig 59 below)



Fig 59.

D. Rollers

To help the smooth running action of the locking mechanism, annually apply a small amount of oil to each side of the rollers (see fig 60).

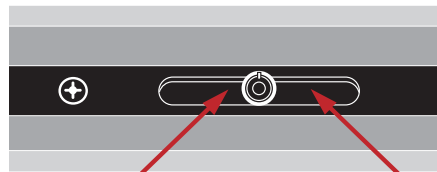

Fig 60. Roller.

Lubrication and Maintenance

Doors

Door locks and keeps

For hinged doors apply industrial Vaseline or other suitable grease to the hook and latch (fig 61) and striker surfaces (fig 62). The lock gearbox has grease applied at time of manufacture which is designed to lubricate the lock for its life span.

Please do not add oil to the gearbox as this will dissolve the grease and reduce the life span of the lock.

Visible lock & keep surfaces should be kept clean from dust and dirt by wiping with a clean, damp cloth.

For sliding doors apply oil to the gearbox (fig 63) and mushroom pins (fig 64)

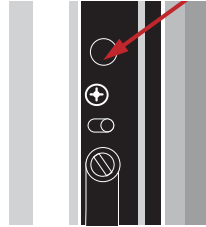

Fig 63. Gearbox.

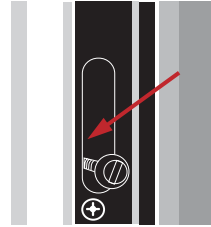

Fig 64. Mushroom pins

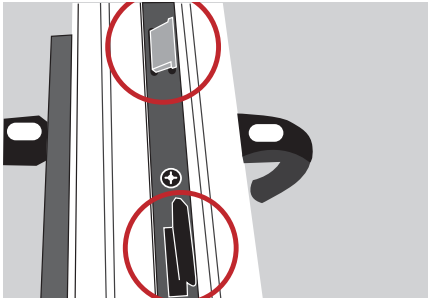

Fig 61. Hook and latch.

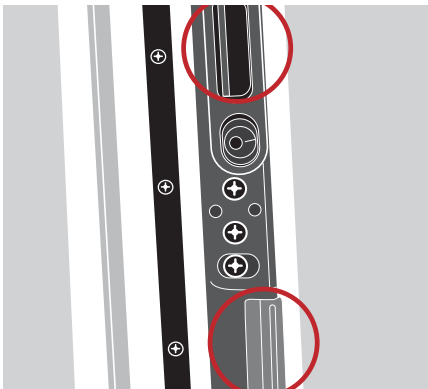

Fig 62. Striker surfaces.

Cylinders

For lubricating your lock cylinders see page 28

Using a Phillips screwdriver, annually tighten your cylinder screw (fig 65) located on the faceplate of the lock.

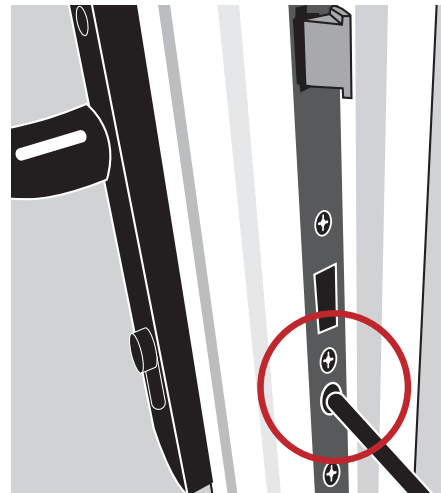

Fig 65. Cylinder screw.



Hinges

PVC-U door hinges (fig 66) are manufactured with self lubricating material and do not need oiling.

Classic door hinges should be lubricated annually by applying a small amount of oil to the hinge pin (fig 67)

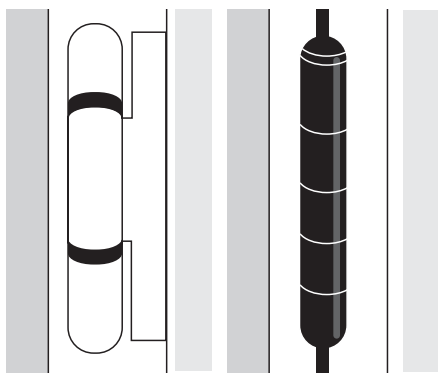

Fig 66

Fig 67

Touching up and repainting composite doors
 Due to the nature of the environmentally friendly water based paint used to coat Classic doors, it is only possible to repair small scratches and chips. Touch up paint is available from your installer. If you want to recoat your door due to damage beyond the capability of touch up paints, this can

only be achieved by following the instructions detailed below.

Site recoating of a Classic door is similar in nature to the recoating of painted timber windows and doors.

- A.** Clean the door to remove dirt and contamination and dry thoroughly.
- B.** Lightly abrade the surface with either abrasive paper grade P600 or scotchbrite pad to provide a key for the paint to adhere to. Then wipe the surface with a damp cloth to remove any dust and then leave to dry completely.
- C.** Mask around the glazing using low tack paper/masking tape and newspaper. The hardware, handle, letter plate and knocker can be removed for ease of painting or masked to protect it. Avoid getting too much paint over the masking tape edges, as this can lead to the paint coating being torn off when removing the tape.

D. Recoat with a good quality proprietary brand of external grade paint using a brush or roller.

Your installer cannot take any responsibility for the compatibility or performance of any material selected. We recommend therefore that you test for suitability on a small area before proceeding further.



Adjustments

Casement Windows

Hinges

You can increase or decrease the friction on the hinge. This can be done by turning the adjuster screw on the hinge (fig 68) clockwise to increase the friction or anti-clockwise to decrease the friction

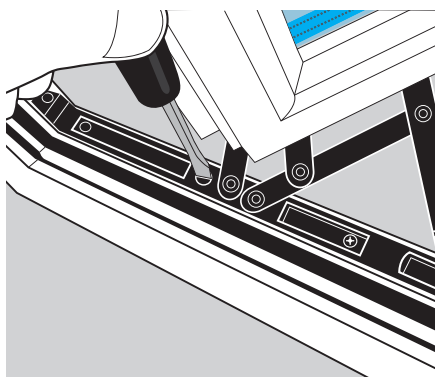

Fig 68. Adjustment screw.

Tilt Turn

Seal Pressures

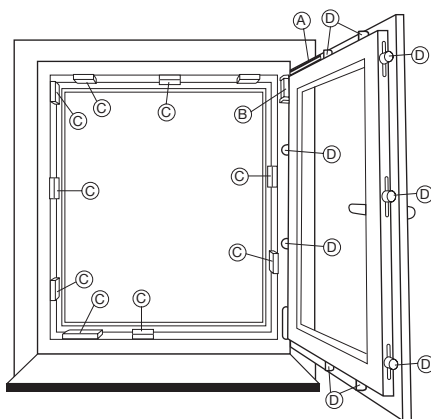

Fig 69.

The seal pressure between the window frame and sash can be manually regulated by adjusting rollers labelled D (fig 69)



There are two types of rollers to adjust. These can both be adjusted + or - 0.08mm. See below for details



Fig 70. Allen Key Adjusted – rotate the roller using a 4mm Allen Key

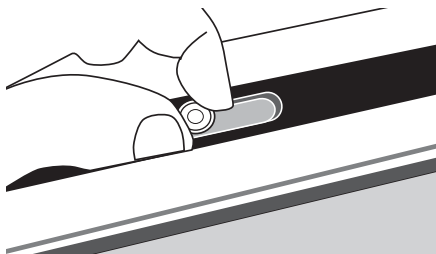

Fig 71. Hand adjusted – lift the roller with your hand and rotate.

Both the Allen key adjusted and hand adjusted rollers have a line on the roller to indicate the amount of adjustment (fig 70 and 71)

When the line is pointing directly outwards the window is at minimum compression and when it's pointing directly inwards it's at maximum compression.

When the window is adjusted these should all point in the same direction (fig 72 and 73)

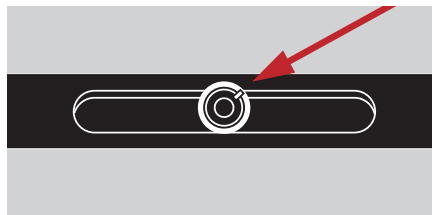

Fig 72.

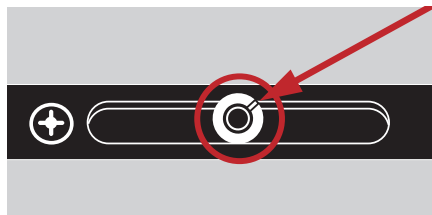

Fig 73.

Residential Doors

The installers will have set up the door to work correctly. We do not recommend any further adjustment.



Trouble Shooting

If you think you have a problem with your windows or doors, before calling for assistance, please read through this trouble shooting guide. There may be a quick and easy fix to your problem.

If there is anything you are not sure about or you do not feel confident carrying out some simple adjustments or repairs, or have a problem that is not listed, please contact your installer for advice or to book for an engineer to visit.

I have a draft around my window/door

Air movement detected near to a window/door may be due to natural currents caused by heating or cooling of the air (known as convection) and is not necessarily due to air leakage through the window/door. In certain weather conditions a small amount of air coming through the seals is acceptable.

If you are experiencing a draught around the sash you can check to see that the 2 rows of seals around the frame have not been dislodged. These can be lightly pushed back into place.

Night/Trickle vents (where fitted) are not designed to be air tight when closed.

You can make adjustments to your Tilt Turn window to change the seal pressure. Instructions for this are in Adjustment section on page 23.

Water visible in my frame

This is nothing to worry about, our windows are designed to drain away any water before it can leak into your property. There are drainage slots on the bottom of the frame that allow the water to drain out between the window and sill.

If you are experiencing any water entering your property, make sure the drainage slots and gaps between the frame and sill are clear of any debris. In addition, check to make sure the seals haven't been dislodged from the frame.



Casement Windows

Problems closing your window

Is the window almost closed?

- Check there is no debris in the frame preventing the window from closing.
- Make sure the handle is in fully opened position before closing and locking your window

Problems opening your window

- Check that the window is not locked with the key
- Make sure there is no obstruction outside preventing the window from opening

Do you have a restricted hinge? (fig 74)

These are designed to only open to about 10 degrees to prevent accidents. To open the window fully, press the button on the slider (circled in figure 74) to disengage the restrictor.

You will be required to do this on both sides of the top hinged window and just the bottom one on a side hinged window.

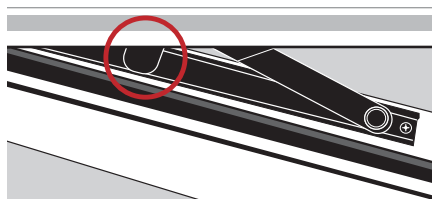

Fig 74. Restricted Hinge

My window is stiff to move
Have you lubricated your hinges, as described on page 18.

If you have been regularly maintaining the windows you can decrease the resistance on the hinge making it easier to operate the window. See Casement Adjustment for details (Page 22).

My window won't stay at the position I open it to
It is possible that the adjuster screw on the hinge is loose.

This can be tightened with a flat head screwdriver to increase the resistance between the slider and the hinge track. See Casement Adjustment for details on page 22.



Trouble Shooting

Handle is loose

Over many years of use your handle fixings may become loose, they can be tightened as shown in the following figures.

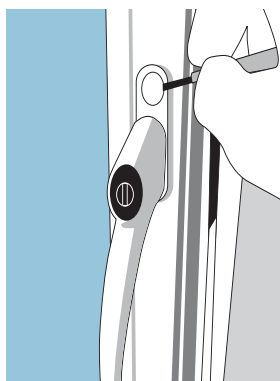

Figure 75. Carefully remove top cover cap using a small flat headed screwdriver.

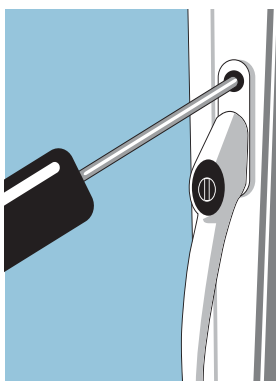

Figure 76. Tighten top fixing using Phillips screwdriver and push cover cap back into place.



Figure 77. Move handle to the open position and tighten bottom fixing

Tilt Turn Windows

Problem closing your window

Is the window almost closed?

- Check there is no debris in the frame preventing the window from closing.
- Make sure the handle is in fully opened position before closing and locking your window

Problems opening your window

- Check that the window is not locked
- Make sure there is no obstruction outside preventing the window from opening

My handle is stiff to move

Have you lubricated the locking mechanism?

Follow the instructions on how to lubricate rollers and keeps in the section on lubrication under tilt turn windows on page 19.

You can adjust your rollers to decrease the compression, see tilt turn seal pressure in the Adjustment section on page 23.

My window is pivoting on only one corner

Under certain operations your tilt turn window can go into both tilt and turn operation at the same time. Although the window is not designed to operate like this, it is perfectly safe and easy to return it to a normal operating condition (see Fig 78-81)

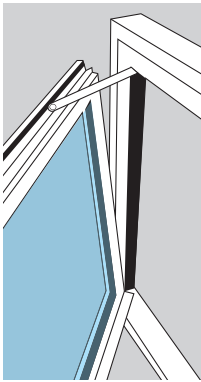

Fig 78.

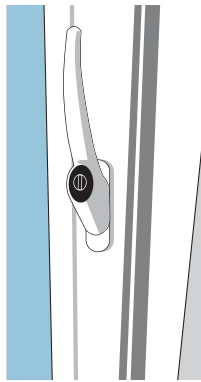

Fig 79. Ensure handle is positioned as shown. Push the bottom corner of the sash on the handle side back into place in the frame.

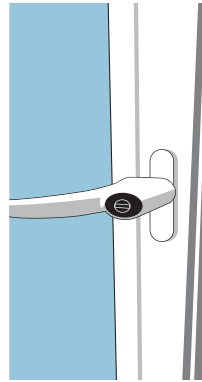

Fig 80. Turn the handle to horizontal.

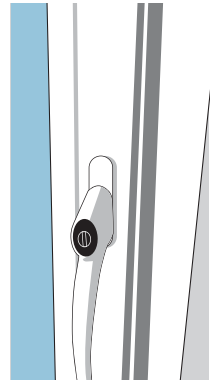

Fig 81. Close your window and turn the handle to the closed position.



Trouble Shooting

Doors

Problems closing your door

Is the door almost closed?

- Check there is no debris in the frame preventing the door closing.
- Make sure the handle is in the fully opened position before closing the door.

Is the door failing to stay closed?

Open the door to check the locking gear operates when the handle is operated. To do this, move the handle to see if the hooks move. If they don't, lubrication could help this, see page 20.

Ensure that the white button (snib) is pushed downwards.

Problems opening the door

- Check that your door is not locked.

My lock cylinder is stiff to operate
The Master Locksmiths Association advises lubricating the cylinder with lock graphite (or graphite pencil).

Apply this lubricant to key only and work the key in and out of cylinder a few times, never apply lubricant directly into the cylinder as this may cause the internal pins to stick.
Do not use WD40 or other oils.

Conservatories

Water in your gutters or boxgutters on your conservatory. Unlike the gutter on your house, which is often fitted at a slight angle, those on a conservatory are laid level. Visible standing water may remain in the gutters as a result of this.

This is perfectly acceptable and in accordance with the code of Practice for Drainage of Roofs. BSEN12056-3:2000.

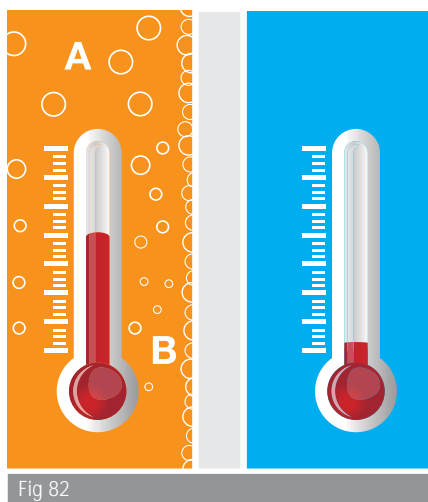

Fig 82

Condensation and sealed units

Condensation

What is condensation?

Condensation is the process of a substance changing from a gas to a liquid and is most commonly used to describe the appearance of water on surfaces. It is normally thought of as occurring when warm moist air comes into contact with cold surfaces, but this can be misleading when trying to understand its cause and in determining actions to prevent it occurring.

The air around us is a mixture of several gases. One of these is water vapour, which is water in a gas state (fig 82 – labelled A)

The amount of water vapour that can be held in the air is dependent upon its temperature. Cold air can hold less than warm air.

The amount of water vapour in the air is measured as a proportion of the maximum amount that could possibly be held at that particular temperature. This is called relative humidity. The importance of this feature is that, for any given relative humidity and air temperature there is another temperature known as dew point.

The dew point is the temperature at which the air can no longer hold the water as water vapour and it starts to appear as liquid water – condensation (fig 82 labelled B)

It is important to remember that the factors influencing the formation of condensation are the relative humidity of the air and the air temperature. These two things determine the surface temperature needed for condensation to form.

For example, the surface temperature required for condensation to occur when the air is warm and very humid is much higher than that needed when the air is cold and very dry.

Condensation and windows/doors

There are three areas of our products where it is possible for condensation to occur.

- The surface of the product which faces onto the building
- The surface of the product which faces the external environment.
- The surfaces within the sealed units

Of these three, only the last is a product fault.

Condensation on the windows on the surface inside the house

Condensation can form on parts of the product that face into the building – the surface which you can touch when standing inside the room – when they are at or below the dew point of the air inside the building in the vicinity of the product.

The temperature of the internal face of the product is dependent upon both the inside and outside temperatures and is therefore within the control of the householder to some extent. We have already determined that the condensation depends upon the relative humidity and the air temperature, neither of which are product related but are within the control of the occupier of the building.

The control of this type of condensation is therefore the responsibility of the householder and its presence is not a product fault and should not lead to a replacement of a sealed unit. As it is not caused by a faulty product, a replacement unit subjected to the same conditions will result in the same type of condensation.

This type of condensation can be controlled by such actions as reducing the humidity through ventilation (figure 83) or ensuring surfaces do not get too cold by increasing room heating.

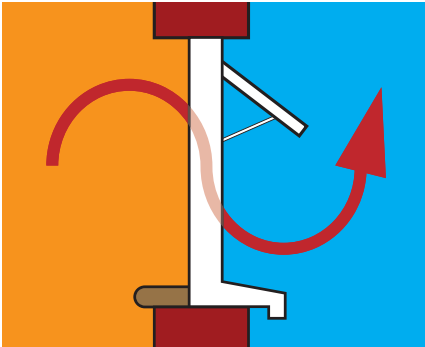

Fig 83.

For more detailed information, refer to the GGF booklet "Condensation some causes, some advice". It is not uncommon for people to describe this kind of condensation incorrectly as "internal" as they interpret internal to mean inside the house rather than inside the sealed unit.

Condensation on the windows on the surface outside the house

It is possible that condensation can form on the surface of the product which faces the external environment (fig 84 – labelled A) – the surface which you can touch when you are standing outside the building.

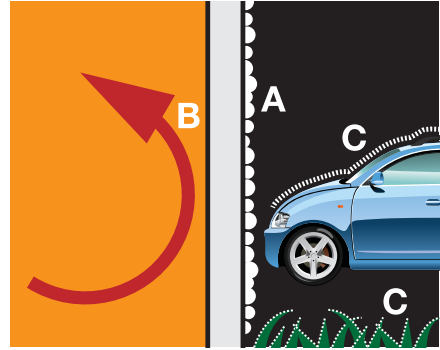

Fig 84.

High performance glazing can result in the outside surface becoming quite cold. This is because (as intended) the heat in the house is being kept inside and is not getting through to heat the outside surface of the glazing (fig 84 – labelled B).

At night, the outside surface radiates heat to the environment, trying to become the same temperature. If the heat from the house is not being transmitted you can see that the outside surface can get quite cold.

If it is a cold, clear night, the outside surface of the glass may become much colder than the air and drop below the dew point of the air. In this circumstance, dew can form on the glass just as it does on the grass or a car (fig 84 – labelled C). The formation of this condensation is actually an indication that the product is doing what you expect of it – keeping the heat in your house and sharing as little as possible with the outside.

Condensation and visual quality of sealed units

This formation is very variable and it is also very common to observe it on one pane and not on others. This is because the dew point of the air can vary. Movement of the air will effect it, as can the presence of nearby vegetation.

Additionally, what is happening inside also has an effect as rooms may be kept at different temperatures resulting in the outside surfaces of different windows being at different temperatures.

The formation of condensation in this way is not a product fault.

Condensation inside the sealed unit

This is between the two panes of the sealed unit and, unlike the other two examples of condensation above, you would be unable to wipe it off with a cloth as you do not have access to the surface where the condensation has formed.

The formation of condensation on a surface within a sealed unit, usually upon the inside face of the external pane, is likely to have been caused by sufficient water penetrating the seal and using up the capacity of the absorbent materials in the sealed unit construction.

This results in a rise in humidity within the space between the two panes and when the temperature of the glass falls below the dew point, condensation occurs. As this condensation is within the sealed unit it cannot be removed.

If this can be observed and the sealed unit is within warranty. Call your installer to arrange an inspection.

Visual quality of sealed glass units

Because of the nature of the glass production process, perfect optical quality and surfaces free of any marks cannot be guaranteed. Some blemishes are to be expected.

The following extracts are based upon recognised European and industry standards. This is supported by the Glass & Glazing Federation document "Visual quality of double glazing – after installation." which forms our basic standard of supply.

Viewing sealed units for scratches on the outer faces of the panes must be carried out as early as reasonably practicable following installation

How to check

- Stand no less than 2 metres away from the panes. 3m for toughened, laminated or coated glass. Where it is not possible to stand the right distance then stand as far away as possible
- Look through the glass not at it
- Check in natural light
- No moisture on the glass surface
- Exclude from the check the 50mm wide band around the edge of the glass.

What to expect when viewed as described

The sealed unit is acceptable if the following are neither obtrusive nor bunched

- Bubbles or Blisters
- Hairlines or blobs
- Fine scratches not more than 25mm long
- Minute particles

If you have any queries regarding the visual quality of your glass please contact the Glass & Glazing federation.

Gutters, Downpipes, Box gutters, Roofline & Fascias

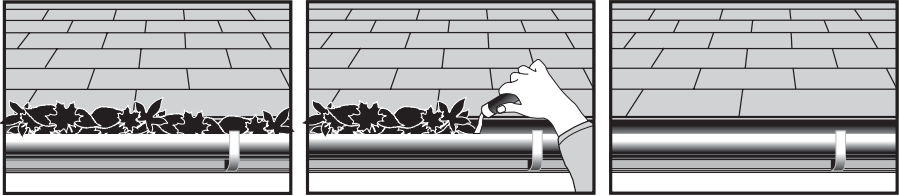

Gutters

All guttering requires annual cleaning and maintenance. The guttering should be accessed safely by use of ladders or scaffold towers dependant on their height/position and carried out by competent/capable persons. All lengths of guttering should be checked annually but more frequently should the property be in close proximity to large trees and bushes where there is an increased risk of foliage becoming trapped within the gutter. All large debris such as leaves and moss should be removed with the use of a small trowel or gutter shovel, the

remaining smaller particles can be flushed to the downpipe using a hosepipe.

During cleaning all joints to couplers, corners and downpipes should be checked for water tightness, alignment and security. The use of pressure washers is not advised.

Leaf Guard can be fitted to prevent excessive collection of debris but this does not substitute annual maintenance.

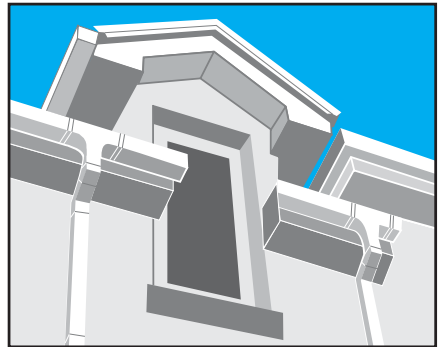
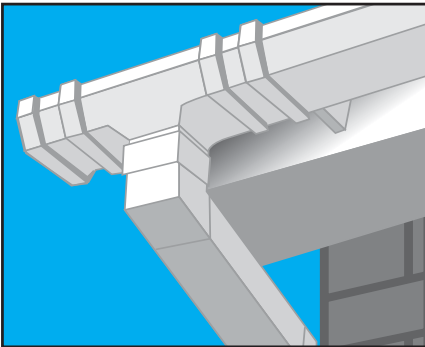

Downpipes

Downpipes should be checked annually, this can be conducted whilst carrying out annual gutter cleaning and maintenance. Downpipes should be accessed safely by use of ladders or scaffold towers and should be carried out by competent/capable persons.

The outlet at the guttering should be checked and cleared of any debris with the use of a trowel or gutter

spade. Large debris such as leaves and moss growth should not be flushed down the pipe as this may cause a blockage further down the pipe. Should there be a blockage to the downpipe which is out of reach flushing with a hose may clear this, but if not rods can be utilised or the downpipe removed and cleared at ground level. Leaf guards can be fitted at the upper outlet to prevent large pieces of debris entering the pipe.

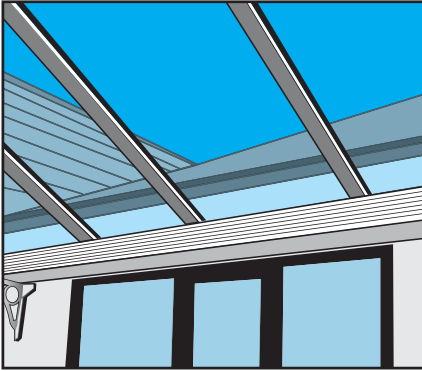

Box gutters

Box gutters should be maintained in the same way as normal guttering although maintenance should be carried out more often.

Access to box gutter systems is generally awkward due to the overhang from both the main property roof and conservatory roof but this should not excuse regular maintenance.

The box gutter along with the remainder of guttering attached around the perimeter of the

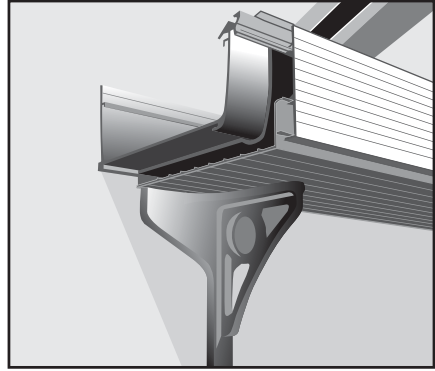

conservatory do not have a fall (i.e. water will not flow readily) therefore the possibility of standing water within these gutter systems can be expected. It is due to this reason that maintenance needs to be more frequent and thorough. Any debris within the gutter will prevent water exiting which will increase the volume of water and weight being held by the gutters and may cause damage to fixing brackets and gutter lengths.

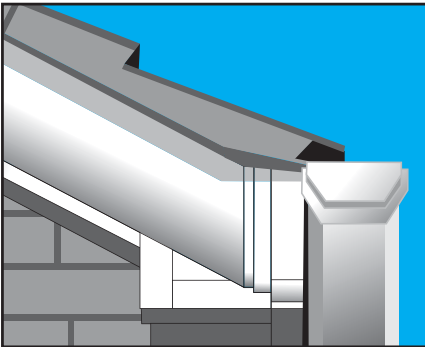

Roofline (Fascias, Soffits, Bargeboards and Dry Verges)

These items require very little maintenance but should be checked annually to ensure that they remain securely fixed to the property. Cleaning should be carried out with the use of non-abrasive products but may not be necessary as frequently as other home improvement products.

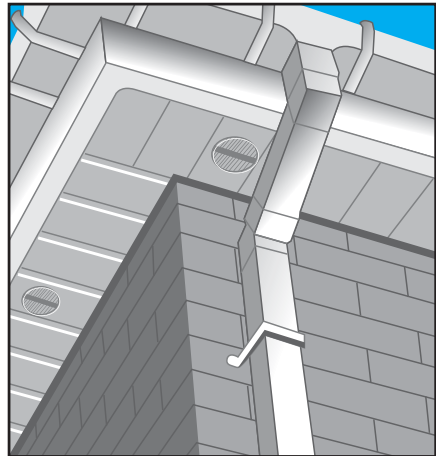

N.B. All Upvc products should be cleaned using non-abrasive cleaning products. If you are unsure of what to use seek advice from manufacturers or local installing companies.



Most commonly asked questions

Q. My door is difficult to close:

A. Check the operation of the lock mechanism with the door in the open position if this operates correctly then the fault is with the alignment. If you have adjustable hinges refer to handbook to make adjustments.

If alignment is good and the mechanism is operating correctly lightly lubricate moving parts to lock were visible and corresponding keeps attached to the frame.

Q. My door is draughty:

A. Check door alignment and make adjustments to lock mechanism/hinges as outlined in handbook.

Q. My window is difficult to close:

A. Clean and clear sliding guide track to window hinges/stays, lightly oil slider track and pivot pins to hinge/ stay assembly. Lightly oil lock mechanism to frame and sash.

Q. My window is draughty:

A. Lightly oil hinge/stays paying particular attention to pivot pins. Adjust lock mechanism if possible refer to handbook.

Q. I suffer condensation to the interior of the room:

A. Double glazing is not guaranteed to eliminate condensation and in some cases it can occur where it had not previously been apparent. Ventilate the room affected; avoid excessive heating of the room without adequate ventilation. Some rooms can typically suffer condensation due to damp air from internally vented tumble dryers, showering and bathing (bathrooms). During periods of extreme cold weather condensation can occur temperature imbalance.

Q. My guttering leaks:

A. Ensure the guttering and all outlets are free from debris permitting free water flow, this needs to be done on an annual basis possibly more often if there are greater quantities of leaf shedding trees in the immediate area.

Q. My guttering leaks at the joints:

A. Ensure gutters are free from debris, remove couplers at joints clear and clean seals and refit. Please note conservatory guttering inherently carries no fall which will permit standing water. This is not a fault.

Q. I can hear whistling/howling noises inside the room:

A. Check all openings to ensure that they are in the fully closed position, check all sealant around the frames if this has deteriorated it can allow air passage and vibration occurs to the fine edge of the sealant. Reapply sealant where required.

Q. I have mould/mildew growth to the sealant:

A. Clean all sealant with a fungal/ mould cleaner most sealants are anti fungal but this can still occur, where necessary it may be required to remove the sealant and reapply.

Q. The sealant around the frames has split and come away internally/externally:

A. The expansion and contraction of the frames can over a period of time cause the frame sealant to break away. Clean off old sealant and reapply.

Q. My window handles do not operate smoothly:

A. Lightly oil lock mechanism and keeps to the frame.

Q. The key will not turn in the door:

A. Ensure the handle has been lifted the required distance to engage the lock mechanism entirely.

Q. Water has penetrating through the window beads and pools on the window cills:

A. The sealed unit is fitted within a glazing cavity and is surrounded by a glazing gasket. It is perfectly normal for water to travel past the gasket into the glazing cavity this should pass out harmlessly through drainage channels incorporating in the plastic profile but can sometimes get routed into the beading slot allowing a small volume of water to pass out internally. This should only occur after heavy rain.

Q. My conservatory leaks after a heavy downpour:

A. Ensure all guttering is clear, check that all roof sheets are correctly aligned and there are no visible gaps between inside and outside. Conservatory roofs are designed to withstand all weather conditions but during periods of heavy downpours the gutter capacity may not be sufficient and water can penetrate glazing seals.

Q. I have white glazing gaskets they have become marked and stained:

A. By the mere nature of white products they will over a period of time become discoloured/ weathered from the forces of nature.

Q. My guttering holds water:

A. Most conservatory guttering systems do not have any fall design into them due to the fitting. Water should flow at some point preventing the guttering overflowing.

Q. My door does not open or close after hot weather:

A. Due to upvc products being made from a form of plastic they are susceptible to expansion and contraction with varying weather conditions (particularly darker colours and wood grain finishes). Either adjust the door on the hinges to allow greater clearance or leave until the weather has cooled. N.B. It is advisable during periods of hot weather when doors are in the closed latched position to engage the multipoint mechanism (lift the handle) to avoid damage to the door from heat.

Q. The polycarbonate roof panels of my conservatory/porch are filled with moisture:

A. Polycarbonate roof panels are not sealed units, they are fitted with a breather tape to permit air passage which can lead to condensation build up within the panels. This should dry out during periods of warmer weather. The closures to the panel ends can be removed and cleared of debris to help assist this.

This booklet offers advice for the maintenance of your installation,
failure to maintain your installation could make your guarantee void.